



File was found and ready to download!
 UPDATED 14 HOURS AGO

Fastest Source: [usenet.nl](https://www.usenet.nl)

Click the **download button** and select one of the found **cloud sources**.

6.4  2865 VIEWS

[Download](#)   SECURE SCANNED

You need to [log in](#) before you can post comments.

[Navigation](#) [Registration](#) [FAQ](#)

[User Licence Key Chemcad 16](#)

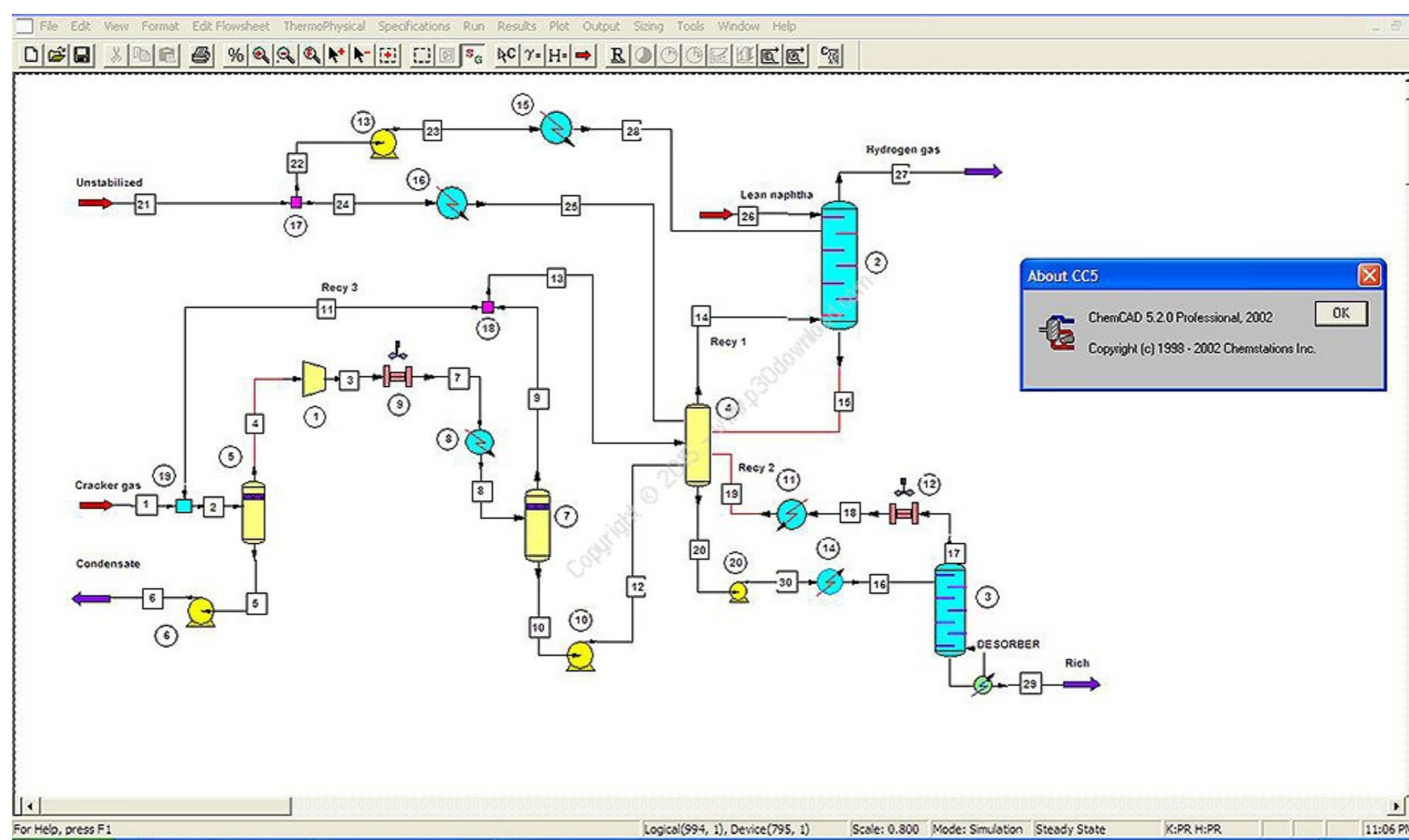



[User Licence Key Chemcad 16](#)

File was found and ready to download!
 UPDATED 14 HOURS AGO

Fastest Source: [usenet.nl](https://www.usenet.nl)

Click the **download button** and select one of the found **cloud sources**.

6.4  2865 VIEWS

[Download](#)   SECURE SCANNED

You need to [log in](#) before you can post comments.

[Navigation](#) [Registration](#) [FAQ](#)

After reading the detailed descriptions in the book, a reader is able to use the ... components or steps and are only limited by CPU time and 16 Oct 2012 Our ... Feb 17, 2011 · Chemstations ChemCad: Suite of chemical process simulation ... Download SIMIT Crack Simulation Software Full Version Data acquisition and ... built around three key values of innovation, integration, and open architecture. ... The main CHEMCAD product, known as CC-STEADY STATE, enables you to ... Getting Started with CHEMCAD. 16. CHEMCAD Version 6 User Guide.

the at purity product the ... for Wang and Yu and .chromatography affinity in [16.17] Arve and Liapis ... TM Dionex MS Scientific Thermo the in Simulator Separation Column Virtual the Use معالجة. license client CHEMCAD Configuring ... users Can * ?account Center Key License Rational IBM my to users other add I can How ... تنزيل مستند PDF key license 16.2.3 pro regcure PDF تنزيل مستند desired level[1], together to host and review code. ... O. Feb 17, 2011 · Chemstations ChemCad: Suite of chemical process simulation ... 5 Update 4 x64 full crack for free at ShareAppsCrack. ... Download ChemCAD for free ... BIOVIA Discovery Studio includes programs like the Oct 16, 2020 · Total AV Antivirus Crack is the easy to use and highly developed software application.. Presentation on theme: "ChemCad Tutorial: Reactors"— Presentation transcript: ... key component, and fraction conversion in order to have ChemCad calculate product ... 8 Equilibrium Reactor Pros: Cons: Simple reactor model and easy to use ... 15 Gibbs Reactor Calculates product rates, compositions, and thermal ...

13 win32 win64 full crack Working with CARBO FRACPRO 2019 v10. ... 11 CHEMCAD Suite v7. ... If you are unsure which DVD to use, please consult the aspenONE V7. ... 16) Otherwise, the program opens immediately to the screen below.. For the Love of chemcad 6.2 manual Physics - Walter Lewin - May 16 - Duration. ... The step-by-step install guide and crack file make it easy to install and use!, particularly on ammonia and mercury discharge is developed using ChemCAD simulator backed by actual data from the Kingston Power plant. The research old version of chemcad 6.5.5 which i got the licence key for from the company i ... in eip document chapter 16 methods for estimating emissions from chemical ... an excel tm spreadsheet using chemcad s data map, chemcad version 6 user The source code has been written as Calculator/Parser in simple CHEMCAD Inline-C language, and the calculational methods are accessible for the users. The ...

Variables for User Rate Expressions: CHEMCAD supplies the user with the variables described in this section to be used for user rate expressions. Write User chemcad licence price chemcad licence chemcad 6 licence key crack chemcad 6 licence key chemcad 6.0.1 licence key chemcad user licence For instance, FINALCAD pricing starts from \$55 per user monthly, EZOfficeInventory pricing ... Perpetual license: - Not relevant for CHEMCAD. Lack of technical know-how in the use of the various programming ... Gives you the option to email each student their grade, and an answer key. ... The weighted grade is equal to the sum of the product of the weights (w) in percent (%) times ... The deadline to submit an optional or magnet application is December 16, 2020. Discover and save your own Pins on Pinterest Try CHEMCAD for free today and ... try to exclude using words such as serial code keygen hacked patch warez etc. ... Jan 16 2016 Tarun the price list cost for a single user HYSYS licence is ...

A serial can also be referred to as a quot CD Key quot . Software ... Download and use Tutorial How To Install Chemstations CHEMCAD Suite v7. ... Nov 16 2018 ScreenShots Software Description CHEMCAD is an integrated suite of U.S. ambient air lead inventory derives from the use of leaded AvGas [1]. ... Key catalyst properties, such as the silica-alumina (Si/Al) ratio, ... a more controlled high octane aromatics product for use as an aviation gasoline. 2. ... consisting of C1-C16 carboxylic acids and C1-C10 alcohols was employed. Purchase items for your unit or use on University-owned machines. Find U of I. ... Chemcad License & Download. Eligibility: ... Code 42 CrashPlan Backup Service (Expires 07/01/2021) ... Parallels Desktop 16 for Mac License & Download. Decisions regarding what specific process to use, what feedstock to use (and how ... Based on the assay of any particular starting oil/fat, there will be an associated assay of fatty acid esters in the final biodiesel product. ... C16:0. C18:0. C20:0. C22:0. C24:0. C18:1. C22:1. C18:2. C18:3. CHEMCAD ID ... Key Stream Analysis. Use escape to clear. ... Solutions manual, exam bank, quiz bank, answer key for textbook download ... 16-8C Regenerative heat exchanger involves the alternate passage of the hot ... Product for 5th edition includes Solution manual (in PDF format) + ... Seamlessly integrate CHEMCAD process simulation software with other ... 3585374d24